

**Do not interconnect** parts of this lighting chain with parts of another manufacturer's lighting chain.

Interconnection shall be made only by the use of the supplied connectors. Any open ends must be sealed-off before use.

### **Warning**

This tree is for INDOOR use ONLY. The tree base MUST be placed on a flat rigid surface.

1. For indoor use only, Do not use outdoors or in moist/humid conditions.
2. Do not operate in a confined space or allow contact with flammable material.
3. Do not allow this product to come into contact with direct heat or flame.
4. Do not operate this product whilst in the packaging.
5. Do not electrically connect this product to any other light set. Do not interconnect parts of this lighting chain with parts of another manufacturer's lighting chain.
6. Disconnect from mains supply whilst not in use. Do not connect the chain to the supply while it is in the packing.
7. The transformer is a sealed unit and must not be tampered with in any way.
8. Wires may come wrapped around frame pieces. Locate and unwrap wires before assembly.

Only use the included transformer

If the flexible cable or the transformer becomes damaged then the complete transformer and cable should be destroyed.

Warning - Risk of electric shock if lamps are broken or missing. Do not use.

### **Shaping Your Tree**

Please assemble the tree with glove.

Start at the bottom of the tree and ensure that each branch has fallen fully into place. Carefully adjust any branches as needed to evenly space them.

With each branch, separate out the individual tips and angle them out and away from the center of the tree. For most tree styles, the tips furthest back on the branch (toward the center pole) should be angled vertically up from the branch and sideways out from the branch so as to resemble a peacock's fanned tail when shaped. We recommend shaping the branches vertically upward as much as possible to give the tree its full appearance. (The tips toward the end of the branch should be angled out and away from the branch and away from the center pole and toward you.)

Work your way around each branch level and then upward on the tree, adjusting each layer before moving upward.

Once you have reached the top of the tree, step back, and look at the tree from a distance.

This allows you to look for any areas that need a bit more fluffing to fill in any gaps.

### **Storage**

Remove all holiday decorations. Gently press tips back into center branch. Raise all branches to original upright position taking care not to place undue pressure on the attached ends of the branches. When disassembling tree, a twisting motion will help to separate the sections from each other. All tree parts can be put back into the carton and should be stored in a cool, dry place.

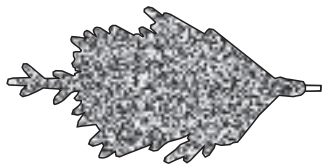

**A** x 1

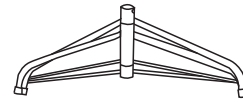

**B** x 1

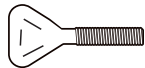

**C** x 3

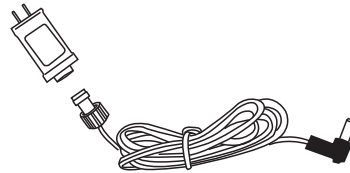

**D** x 1

01

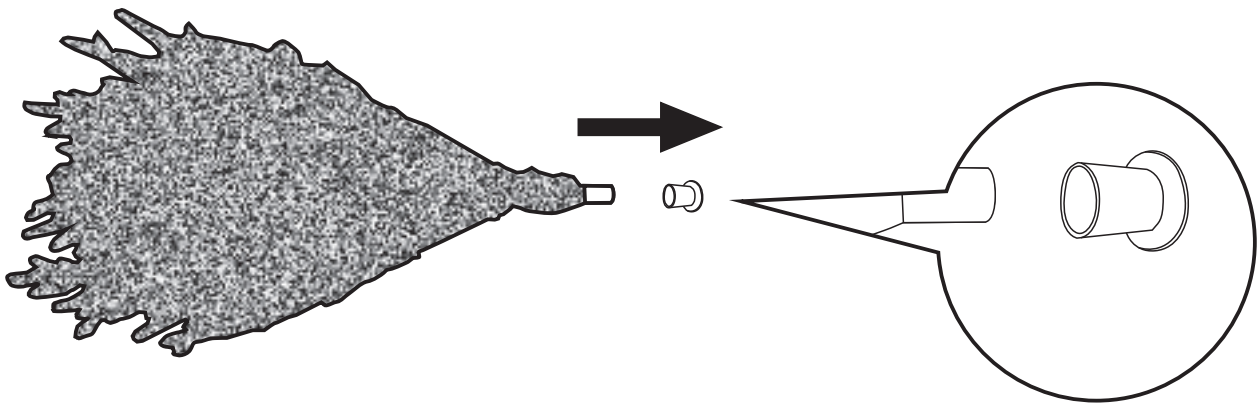

**EN\_NOTE:** Please remove the circular protector caps on the end of each pole before assembling.  
If the caps were broken, It will not affect the use of.

**FR\_REMARQUE :** Veuillez retirer les capuchons de protection circulaires à l'extrémité de chaque tige avant de les assembler.

Si les capuchons sont cassés, cela n'affectera en rien l'utilisation du produit.

**ES\_NOTA:** Por favor, retire las tapas protectoras circulares de los extremos de cada poste antes de empezar a montar.

Si las tapas se rompen, esto no afectará en ningún caso al uso normal del producto.

**DE\_HINWEIS:** Bitte entfernen Sie vor dem Zusammenbau die runden Schutzkappen an den Enden der Stangen.

Wenn die Kappen zerbrochen sind, hat dies keinen Einfluss auf die Verwendung des Baumes.

**IT\_NOTA:** rimuovere i cappucci protettivi circolari all'estremità di ciascun palo prima di montarli.

Se i cappucci sono rotti, questo non influisce sull'uso.

02

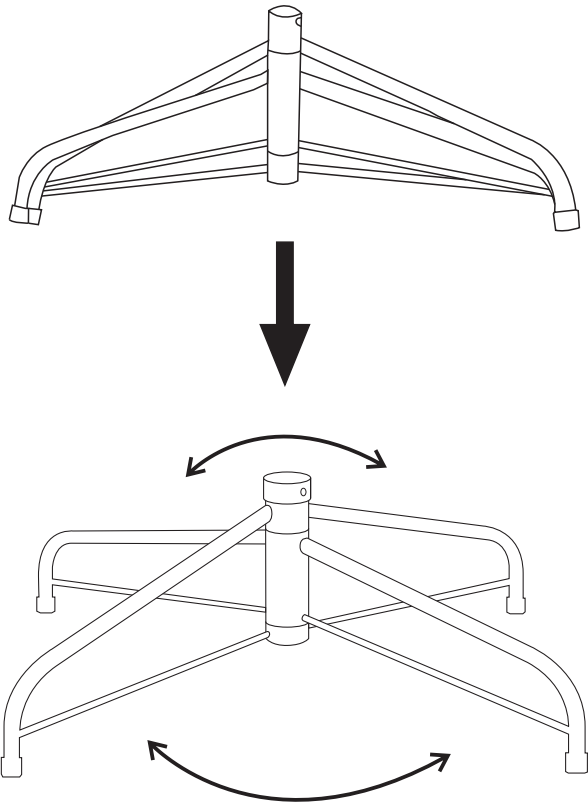

03

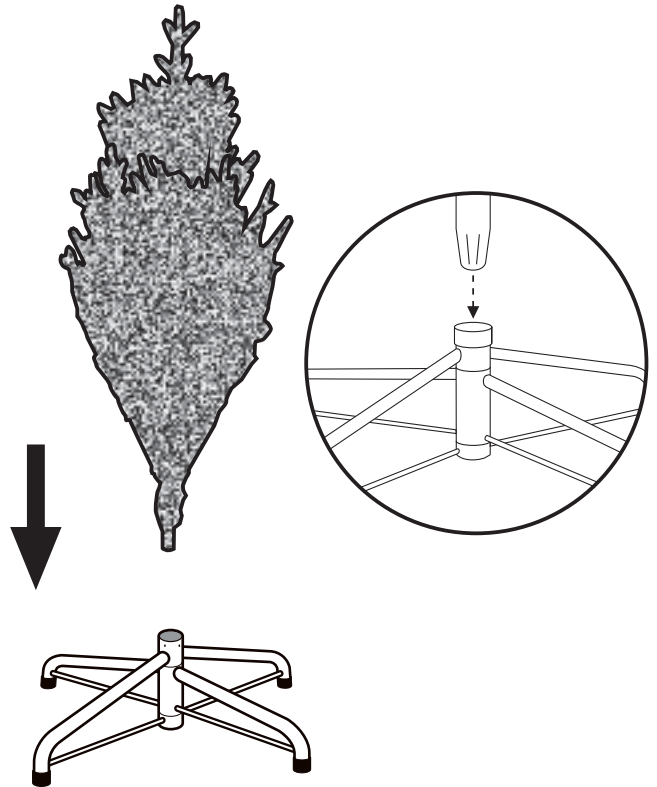

04

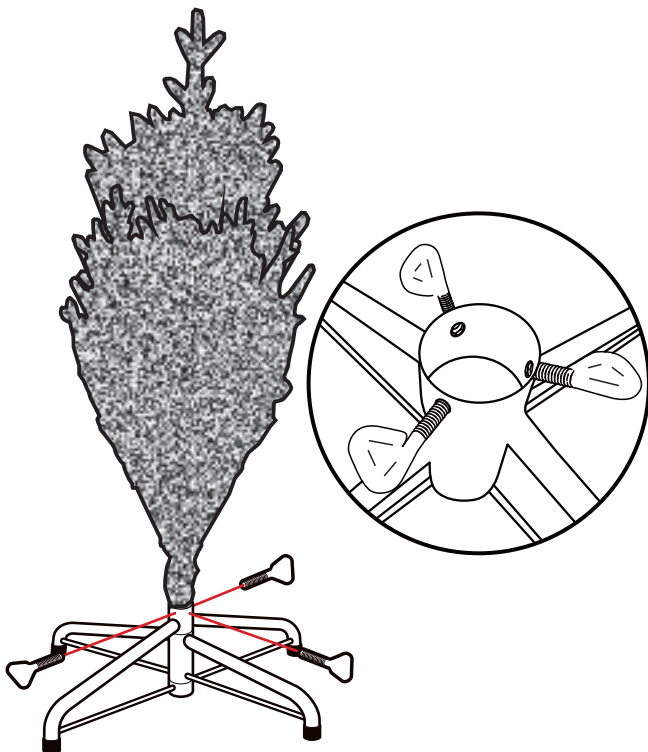

05

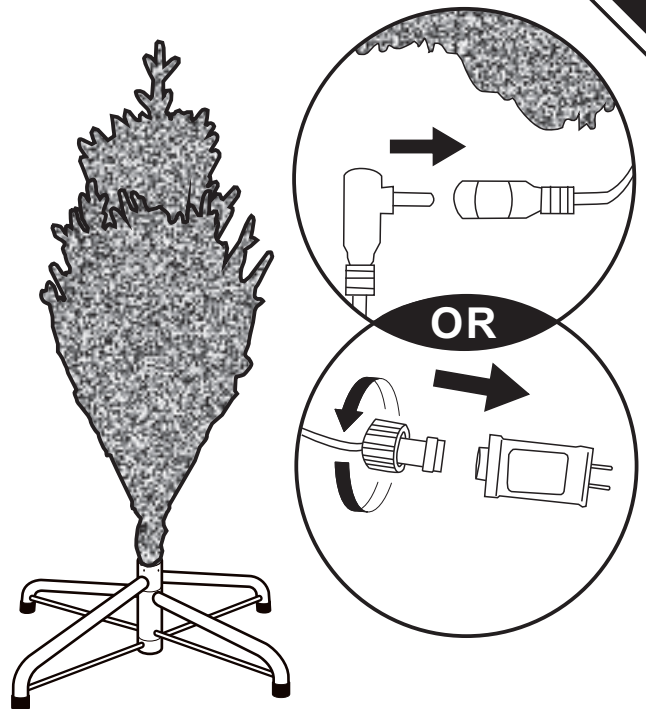

*EN\_* connect the transformer  
*FR\_* Brancher le transformateur  
*ES\_* Conectar el transformador  
*DE\_* Schließen Sie den Umspanner an  
*IT\_* connettere il trasformatore



### EN\_Shaping the Tree Branches

You can shape the tree branches working with each row individually, and working your way from the inner tips outward on each branch. Shape the tips to fill gaps between branches to make the tree full and natural looking.

The branches need to be expanded manually and take some time to get the final effect of the picture

### FR\_Façonnage des branches d'arbre

Vous pouvez façonner les branches du sapin en travaillant sur chaque rangée individuellement et en partant des extrémités intérieures vers l'extérieur de chaque branche. Formez les extrémités pour combler les espaces entre les branches et donner au sapin un aspect étoffé et naturel.

Les branches doivent être élargies manuellement et il faut un certain temps pour obtenir l'effet final de l'image

### ES\_Dar forma a las ramas del árbol

Puede dar forma a las ramas del árbol trabajando con cada fila individualmente, y trabajando desde las puntas interiores hacia fuera en cada rama. Dale forma a las puntas para llenar los espacios huecos entre las ramas para que el árbol tenga un aspecto completo y natural.

Se deben expandir las ramas manualmente y va a requerir algo de tiempo para obtener el efecto final mostrado en la imagen.

### DE\_Formen der Äste

Sie können die Äste formen, indem Sie jede Reihe einzeln bearbeiten und sich von den inneren Astspitzen nach außen arbeiten. Formen Sie die Spitzen, um Lücken zwischen den Zweigen zu füllen, damit der Baum voll und natürlich aussieht.

Die Zweige müssen manuell ausgebreitet werden und Sie brauchen etwas Zeit, um den endgültigen Effekt des Bildes zu erzielen

### IT\_Dare forma ai rami

È possibile modellare i rami lavorando ogni fila individualmente e procedendo dalle punte interne verso l'esterno su ciascun ramo. Modellare le punte per riempire gli spazi tra i rami e rendere l'albero pieno e dall'aspetto naturale.

I rami devono essere espansi manualmente e serve del tempo per ottenere l'effetto finale dell'immagine sottostante.

